



**TG-161S1**  
40-100W



**TG-161S**  
100-200W



**TG-161M**  
200-300W



**TG-161L**  
320-480W





简述 Description



- 灯具外壳采用铝合金压铸而成，灯具电器箱和光源模组采用分离式独立结构
  - 高透光PC透镜，具有高视觉舒适性和均匀配光透镜，供多种不同配光选择
  - 电器箱采用独特设计，安全快捷开启，整体防护IP66
  - 防紫外线聚氨酯塑粉喷涂表面，盐雾测试可以达1000小时以上
  - 无生物蓝光危害风险，符合EN62471: 2008标准
  - 所有外部螺钉均为304不锈钢材质
- Die-casting aluminum alloy housing, the electrical box and light module adopt separate independent structure.
  - Optics with PC lens with high visual comfortable and uniform lighting distribution, multiple light distribution options.
  - The electrical box adopts unique design, safe and fast opening, and the overall protection is IP66.
  - Surface anti-ultraviolet pure polyester powder painting, Corrosion resistance can be more than 1000 hours.
  - No photo-biological risk, (no risk linked to infrared, blue light and UV radiation) in accordance with EN 62471:2008.
  - All external screws are made of 304 stainless steel.

抗振等级: 通过5G / 15Hz / 3轴各10万次振动测试  
 风压测试: >65m/s  
 功率: 40W-480W  
 光效: 110-135 Lm/W  
 色温: 3000K / 4000K / 5000K  
 显色指数: >80Ra / 90Ra  
 功能选项: 0-10V / DALI / DMX / RGBW

Anti vibration grade: Passed 100K times vibration tests of 5G / 15Hz / 3 axis.  
 Wind pressure test: >65m/s  
 Power: 40W-480W  
 Nominal efficacy: 110-135 Lm/W  
 CCT: 3000K / 4000K / 5000K  
 CRI: >80Ra / 90Ra  
 Options: 0-10V / DALI / DMX / RGBW

- 应用场合: 体育馆、港口码头、机场及大型建筑立面泛光照明
- Applications: Sport stadium, port, and larger building illumination.

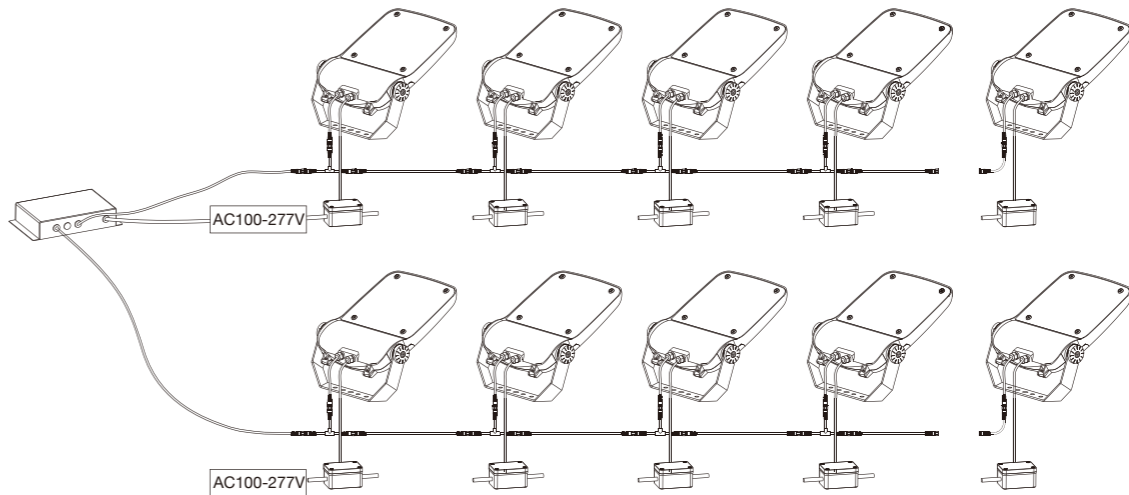



特殊散热翼形设计，有利于散热，不易积灰尘  
Special heatsink design, it helps to have a good heat radiation and it have good cleaning effect by itself.



IK08钢化玻璃罩，可适配Zhaga标准PCB板，模组透镜供多种不同光型可选，以满足不同场合的照明需求

IK08 tempered glass, it is suitable for Zhaga standard PCB board. Modular lens is available for various light types to meet the lighting requirements of different place.



灯具安装时通过瞄准器精准控制光的投射位置，角度调整完毕后装上安全绳，能防止灯具的意外跌落

When installing lamps and lanterns, the projection position of the light is precisely controlled by the aiming sight, and the safety rope is installed after the angle adjustment, which can prevent the lamps and lanterns from falling unexpectedly.

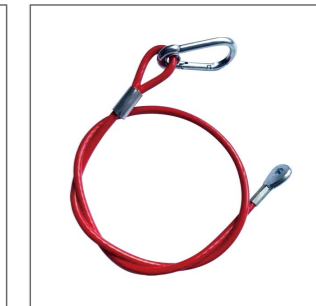

独立电气室隔离，快速拆卸尾盖设计，电气安装维护安全方便

Isolation of independent electrical housing, plug-cover design, safety and convenience for the maintenance of electrical.



## TG-161 Series

一组实用型高端LED投光灯，灯具共有4个尺寸版本，分别功率从40W-480W，可适用于不同场合功能照明需求，多种光学系统可选配。

A practical high-end LED flood lighting with 4 sizes to option, and the power from 40W to 480W. It can be used for lighting requirements of different application scenarios. A variety of optical systems can be selected.

4  
SIZES



"L" 型灯具安装支架设有不锈钢刻度面板，并设有塑料装饰盖

"L" version luminaire mounting bracket with stainless steel scale panel and plastic decorative cover.

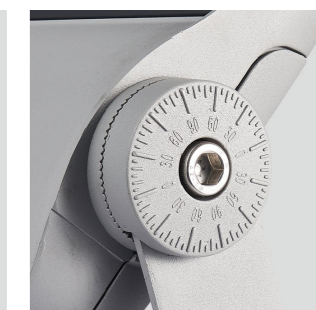

精准角度调节，其他尺寸灯具设有铝压铸刻度装饰盘

Precision angle adjustment, "other size luminaire with aluminum die casting scale decorative plate.

## 不对称反光杯 Asymmetric reflector optics

"A" reflector only suit for "L" and "M" version

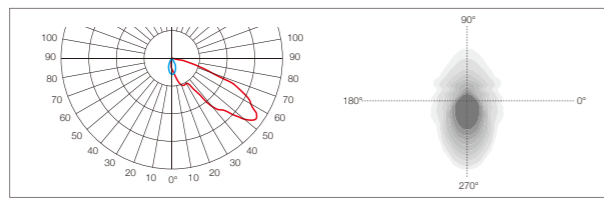
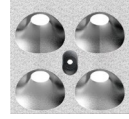

**A1**  
适用于运动场、广场、十字路口、停车场等区域照明  
Asymmetrical Optic  
For sports ground, square, intersection, parking and other areas.

LED Chips: 4 in 1

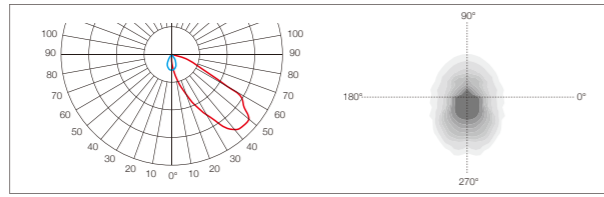

**A3**  
适用于运动场、广场、十字路口、停车场等区域照明  
Asymmetrical Optic  
For sports ground, square, intersection, parking and other areas.

LED Chips: 4 in 1

## 组合不对称透镜 Asymmetric lens optics

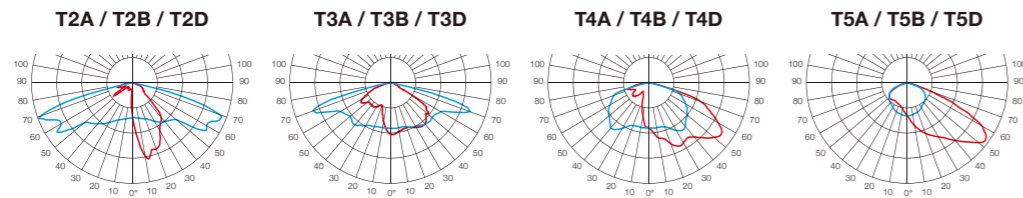

## 组合对称透镜 Symmetric lens optics

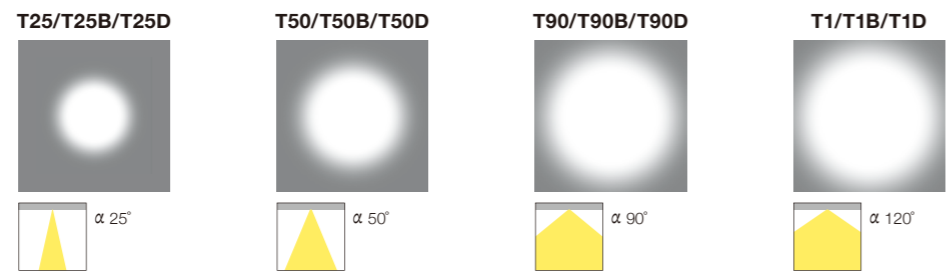

## 对称反光杯 Symmetric reflector optics

"R" reflector only suit for "L" and "M" version

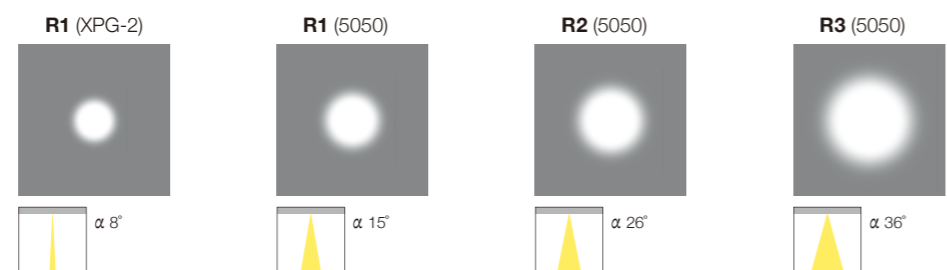
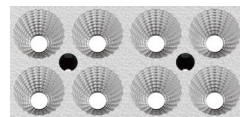

技术参数 Technology data



**TG-161L**

Code	Power	LED Qty	Optics	Packing Size	Weight	Pcs/20"	Pcs/40"
LED chips - 3535/5050							
TG-161LLED320-120	320W	120	T10/T25/T50/T90/T3A/T4A	785*610*165	19.4	325	689
TG-161LLED400-144	400W	144	T10/T25/T50/T90/T3A/T4A	785*610*165	19.8	325	689
TG-161LLED480-168	480W	168	T10/T25/T50/T90/T3A/T4A	785*610*165	19.8	325	689
LED chips - XHP50							
TG-161LLED320-48	320W	48	A1/A3	785*610*165	19.8	325	689
TG-161LLED420-48	420W	48	A1/A3	785*610*165	19.8	325	689
LED chips - XML COLOUR							
TG-161LLED480-48RGBW	480W	48	TS25/TS40/TS60	785*610*165	19.8	325	689

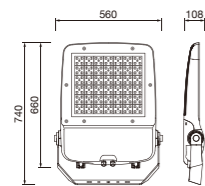

**TG-161M**

Code	Power	LED Qty	Optics	Packing Size	Weight	Pcs/20"	Pcs/40"
LED chips - 3535/5050							
TG-161MLED200-80	200W	80	T10/T25/T50/T90/T3A/T4A	660*470*115	12.0	738	1548
TG-161MLED240-96	240W	96	T10/T25/T50/T90/T3A/T4A	660*470*115	12.1	738	1548
TG-161MLED300-96	300W	96	T10/T25/T50/T90/T3A/T4A	660*470*115	12.2	738	1548
LED chips - XPE							
TG-161MLED240-96RGBW-S	240W	96	T1/TP25/TP40/TP60	660*470*115	13.0	738	1548

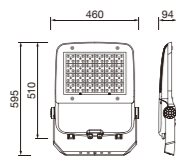

**TG-161S**

Code	Power	LED Qty	Optics	Packing Size	Weight	Pcs/20"	Pcs/40"
LED chips - 3535/5050							
TG-161SLED120-36	120W	36	T25/T50/T90/T1/T3A	500*395*110	8.2	1344	2898
TG-161SLED150-48	150W	48	T25/T50/T90/T1/T3A	500*395*110	8.2	1344	2898
TG-161SLED200-72	200W	72	T25D/T50D/T90D/T1D/T3D	500*395*110	8.2	1344	2898
LED chips - 3030							
TG-161SLED120-126	120W	126	T25B/T50B/T90B/T1B/T3B	500*395*110	7.9	1344	2898
TG-161SLED150-168	150W	168	T25B/T50B/T90B/T1B/T3B	500*395*110	7.9	1344	2898
TG-161SLED200-210	200W	210	T25B/T50B/T90B/T1B/T3B	500*395*110	7.9	1344	2898
LED chips - XPE							
TG-161SLED150-48RGBW-S	150W	48	T1/TP25/TP40/TP60	500*395*110	8.2	1344	2898

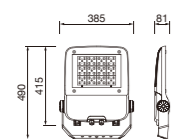

**TG-161S1**

Code	Power	LED Qty	Optics	Packing Size	Weight	Pcs/20"	Pcs/40"
LED chips - 3535/5050							
TG-161S1LED40-24	40W	24	T25/T50/T90/T1/T3A	400*295*105	3.6	2420	5038
TG-161S1LED60-24	60W	24	T25/T50/T90/T1/T3A	400*295*105	3.6	2420	5038
TG-161S1LED75-36	75W	36	T25/T50/T90/T1/T3A	400*295*105	4.0	2420	5038
TG-161S1LED100-36	100W	36	T25/T50/T90/T1/T3A	400*295*105	4.0	2420	5038
LED chips - 3030							
TG-161S1LED75-84	75W	84	T25B/T50B/T90B/T1B/T3B	400*295*105	4.0	2420	5038
TG-161S1LED100-126	100W	126	T25B/T50B/T90B/T1B/T3B	400*295*105	4.0	2420	5038
LED chips - XPE							
TG-161S1LED75-36RGBW-S	75W	36	T1/TP25/TP40/TP60	400*295*105	4.0	2420	5038

